

ΕΠΛ 427:
ΚΙΝΗΤΑ ΔΙΚΤΥΑ ΥΠΟΛΟΓΙΣΤΩΝ
(MOBILE NETWORKS)

Δρ. Χριστόφορος Χριστοφόρου
Πανεπιστήμιο Κύπρου - Τμήμα Πληροφορικής

1G – 5G Mobile Cellular Networks

Introduction

Communication and Wireless Networks

1

- Wireless Networks **utilize Electromagnetic Waves** (radio waves) **of a certain frequency (Carrier Frequency)** to establish **Communication Channels** and **transmit data** between Wireless Communication Devices (e.g., Mobile Devices and the Base Station).

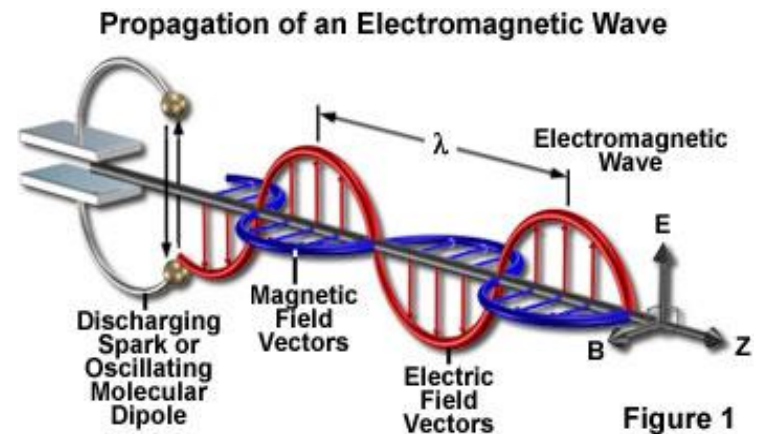

Introduction

Communication and Wireless Networks

2

- This is a **major challenge** for Wireless Networks since with this **Unguided communication** over a **wireless link** the **Quality of the received signal** can be affected by:
 - Many (environmental) factors
 - Noise and Interference
 - The effects caused by the **Multipath Propagation phenomenon**.

Introduction

Multipath Propagation Phenomenon

3

- When the radio waves reach close to an obstacle, the following propagation phenomena do occur to the waves:

- **Reflection (Αντανάκλαση)**
- **Scattering (Διασκόρπιση)**
- **Diffraction (Περίθλαση)**

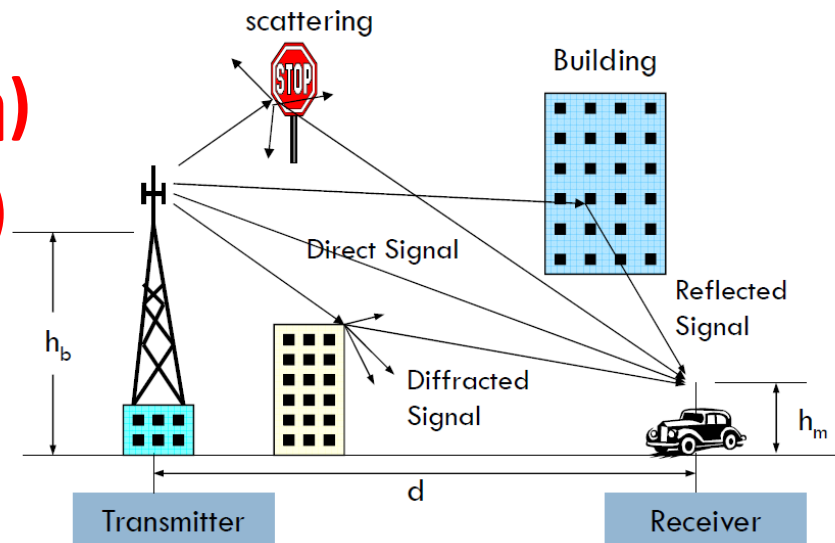

Reflection, Scattering and Diffraction leads to Multipath Propagation!
Many copies of the same signal (referred also as symbol) will reach the Receiver from many paths of different lengths!

Introduction

Multipath Propagation Phenomenon

4

- Transmission paths between **Sender** and **Receiver** could be:
 - **Direct Paths** (Απευθείας Μονοπάτια) → **LOS** between Transmitter and Receiver.
 - **Indirect Paths** (Εμμεσα Μονοπάτια) → Resulted by **Scattering**, **Diffraction** and **Reflection** by buildings, mountains, street signs, foliage, etc.

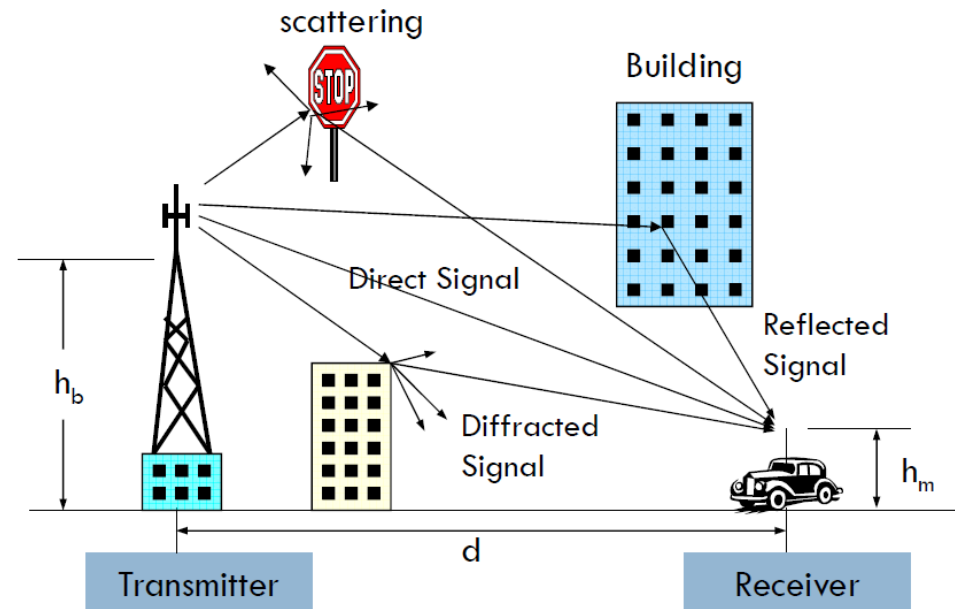

Introduction

Multipath Propagation Phenomenon

5

- Thus, the Received signal is made up of several paths of **different length** which can be classified as:

1. Direct Path
2. Reflected Path
3. Scattered Path
4. Diffracted Path

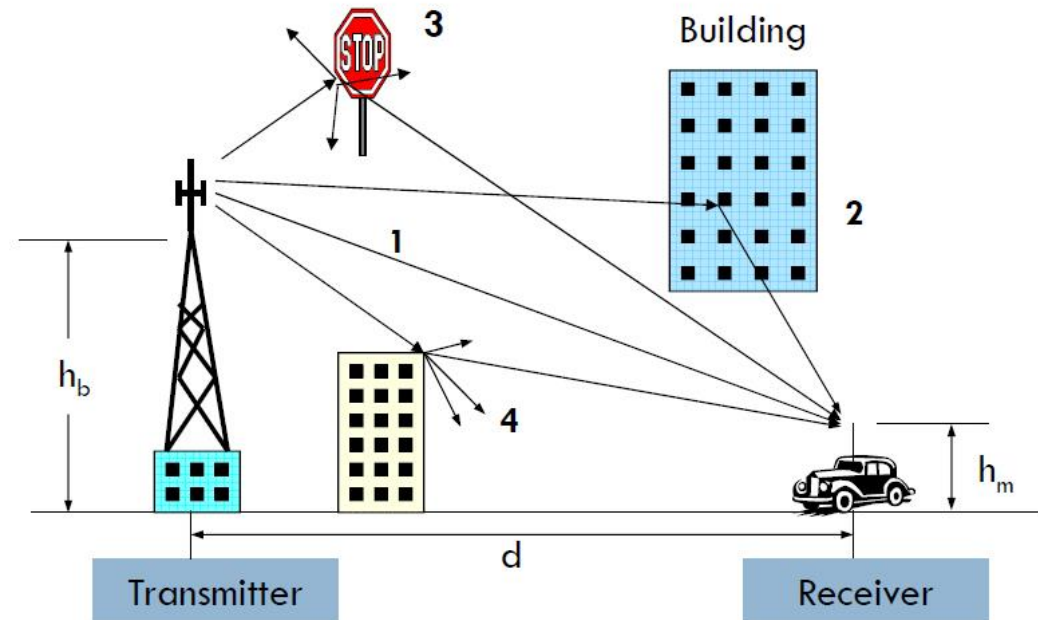

- In this case, the Receiver will receive **four copies** of the same signal **from four different paths**.

Introduction

Delay Spread

6

- Since each path has a **different path length**, the **time of arrival** of each copied signal at the Receiver is **different** causing the **Delay Spread** phenomenon.

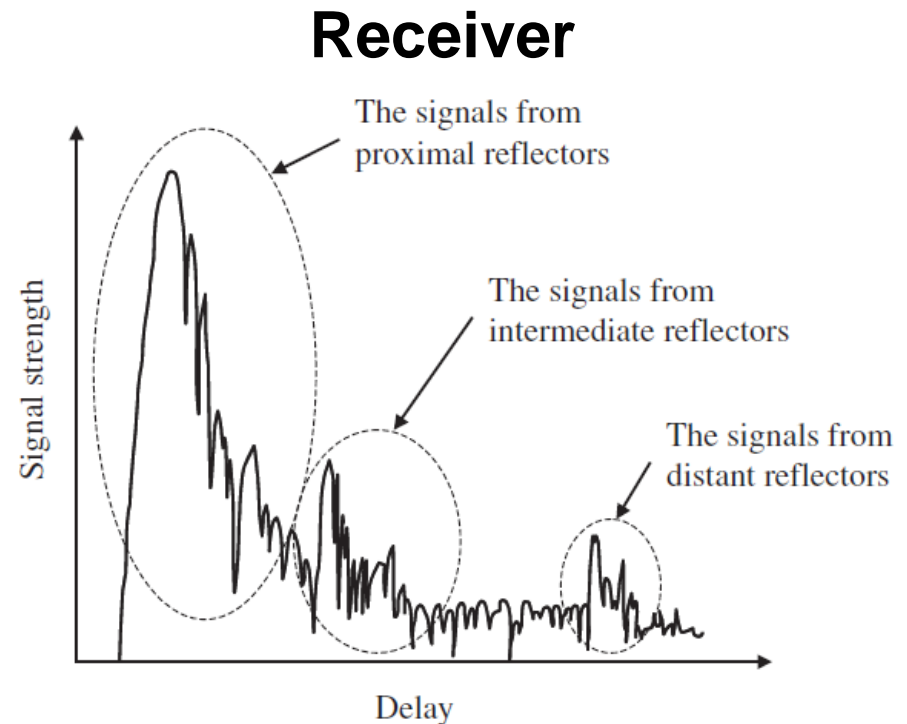
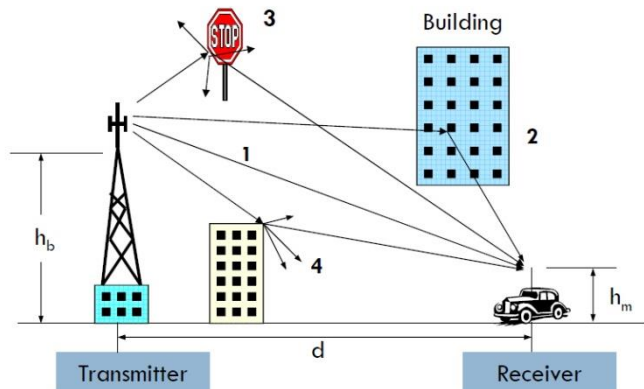

Introduction

Inter-Symbol Interference (ISI)

7

- ISI is the Interference that can be caused between **two subsequent signals/symbols**, transmitted from the Transmitter to the Receiver
 - Due to the **Delay Spread**, the **energy indented for one symbol spreads over to an adjacent symbol** (appeared as Interference).
 - The **shorter the time between two subsequent symbols**, the higher the possibility of **Inter-Symbol interference (ISI)**.

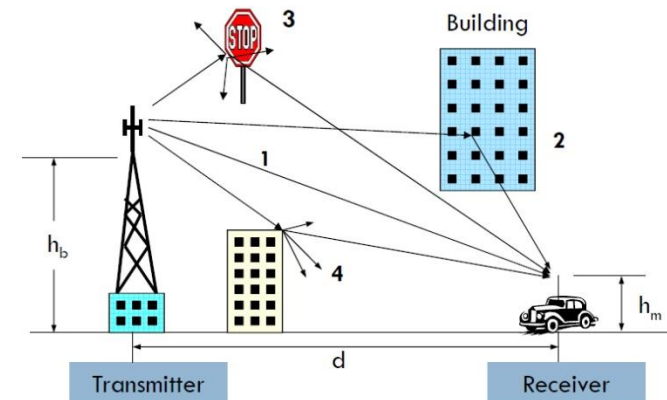
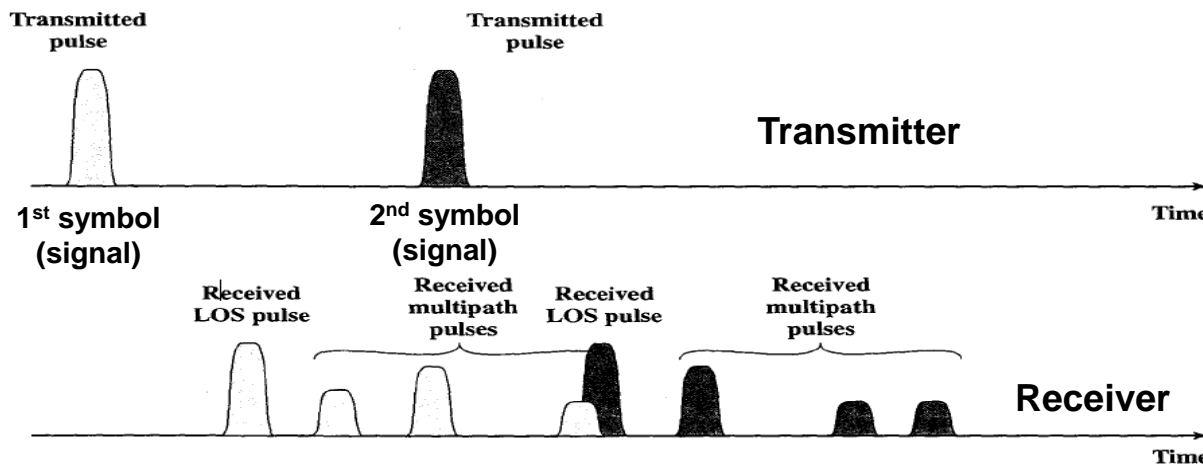

- Due to this interference, the **signals of different symbols can cancel each other out**, leading to **misinterpretation (παρερμηνευση)** at the receivers and causing errors during decoding.

Mobile Cellular Networks

8

- **Mobile Cellular Networks concept:**
 - In a **Cellular Network** a geographical area is **split** into several **smaller land areas** called **Cells**, each served by a **fixed Base Station**.
 - **Service continuity** within this area is achieved by **handover**, which is the **seamless transfer of a call** from one Base Station to the other as the Mobile Station crosses Cell boundaries.

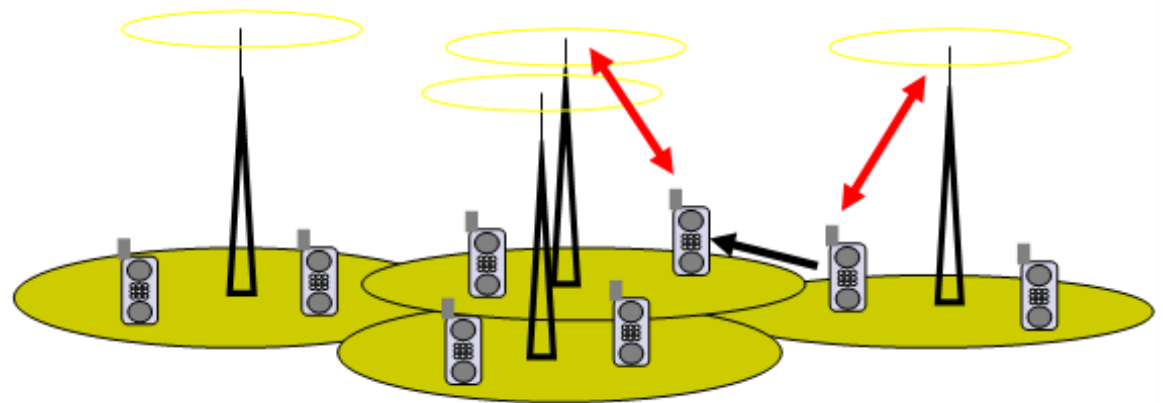
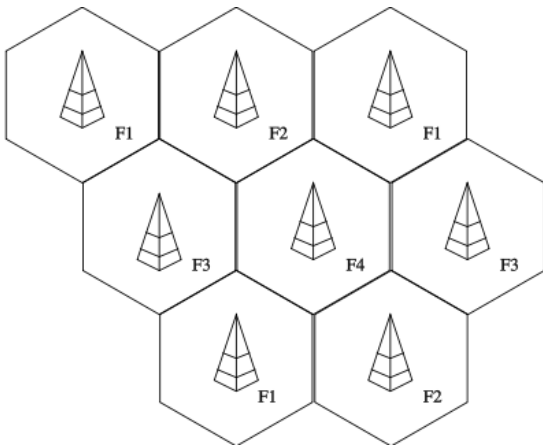

Cellular Network Advantages

9

Question: Why mobile network providers install several thousands of Base Stations throughout the country (**which is quite expensive**) and do not use powerful transmitters with huge cells?

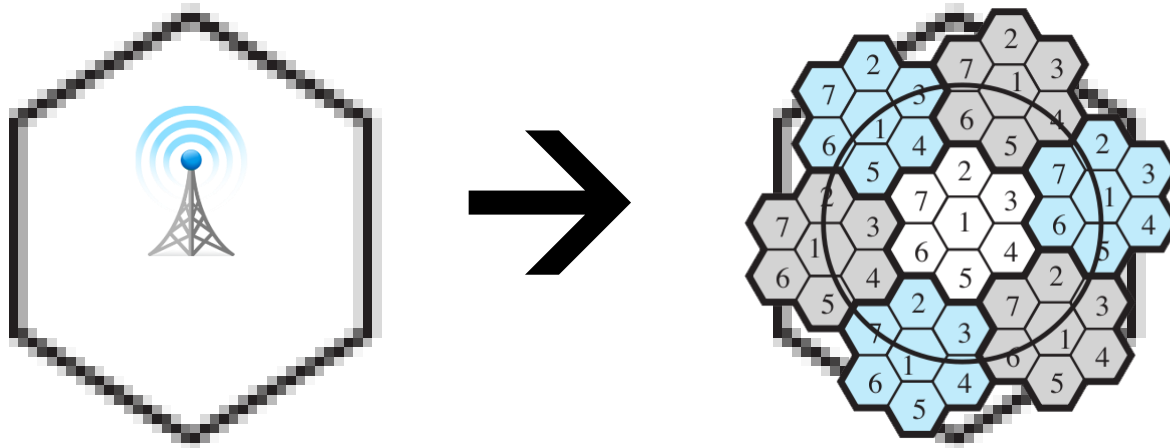

Cellular Network Advantages

10

Answer: Because Cellular Network provides:

- **Higher Capacity** since smaller cells are used and the **frequency reuse concept** is applied
- **Less Transmission Power** is **required by the MS** to reach the BS, and vice versa, in shorter distances → Thus less the energy consumption (**improves battery life** for the MSs, lower power emissions thus positive health impacts, etc.)
- **Interference is Reduced** as less transmission power is required for the signal to cover shorter distances, thus less intra- and inter- cell interference.
- More **Robustness** to the network as if one BS fails, only one small part of the network will be affected.

Mobile Cellular Networks Evolution (1G, 2G, 2.5G, 3G, 4G, 5G)

11

- **1G:** First Commercial Cellular Network (Only Voice) → ~1980s
- **2G:** Started with GSM (Voice and SMS) → ~ 1992
- **2.5G:** Added Packet Switched Services (GPRS, EDGE) → ~ 2000
- **3G:** Added 3G (WCDMA) Air Interface (UMTS) → ~ 2001
- **4G:** Redesigned the **Radio Network** (based on OFDMA Air Interface) and the **Core Network** (New All-IP Core Network) → ~ 2012 (Long Term Evolution (LTE))
- **5G:** Future Networks. Demands for tremendous data traffic and massive mobile device support is foreseen by 2020.
 - New architectures, methodologies and technologies, are needed to make current Cellular Networks sufficient to support these demands.

1G – AMPS (Advanced Mobile Phone System)

12

- ❑ **First Commercial Cellular Network**
- ❑ Launched around beginning of 1980s and replaced in early 1990s by the 2G Wireless Telephone Technology (GSM)
- ❑ Frequency band: 800 MHz
- ❑ The AMPS Network was **designed to offer a single Circuit-Switch (CS)** service (only speech) with speed up to 2.4kbps
- ❑ Based on **FDMA** multiplexing scheme
- ❑ Allowed users to make call **only in one country**



2G – GSM (Global System for Mobile Communications)

13

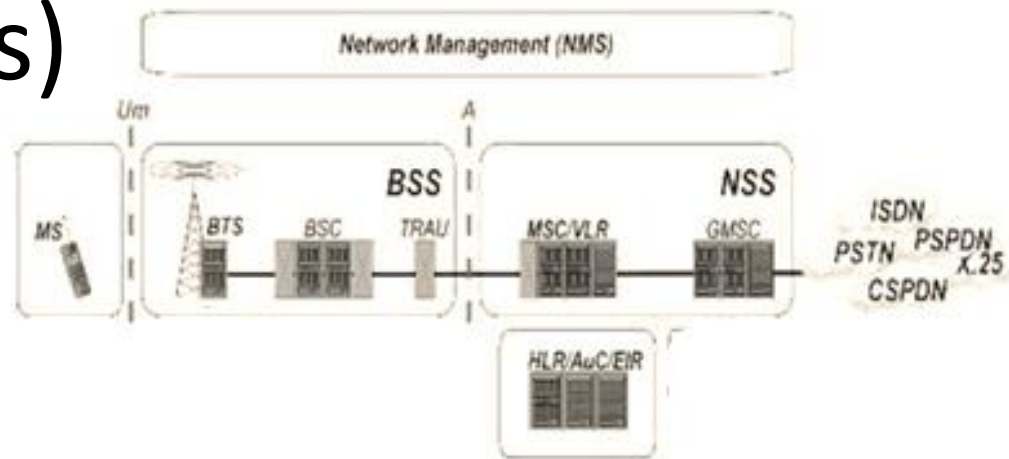

- First launched around 1992
- Frequency bands for Europe (GSM 900, GSM 1800)
 - ▣ GSM 900: Frequency bands around 900 MHz
 - ▣ GSM 1800: Frequency bands around 1.8 GHz
- The basic GSM Network offered **9.6 Kbits/s Circuit-Switch (CS) Symmetric Data connections** between the Network and the Terminal
- Besides the traditional **speech service** these networks were able to provide some **data services (e.g., SMS)** and more **sophisticated supplementary services (e.g., Voice Mail, International Roaming, etc.)**
- Based on **TDMA/FDMA** multiplexing scheme

2.5G – GPRS (General Packet Radio Service) (1/2)

14

- A great majority of traffic started to become **Packet-Switched (PS) (Data Services)** and **Asymmetric** rather than **Circuit Switched (Phone calls)** and **symmetric**
- Therefore, the **GSM Network** is **upgraded** and introduced the **General Packet Radio Service (GPRS)**
- GPRS needs to establish a **Packet Switch connection** through the **GSM Network** to the **Internet**. **GPRS Packet Core** have been included with **two additional nodes** :
 - Serving GPRS Support Node (**SGSN**)
 - Gateway GPRS Support Node (**GGSN**)

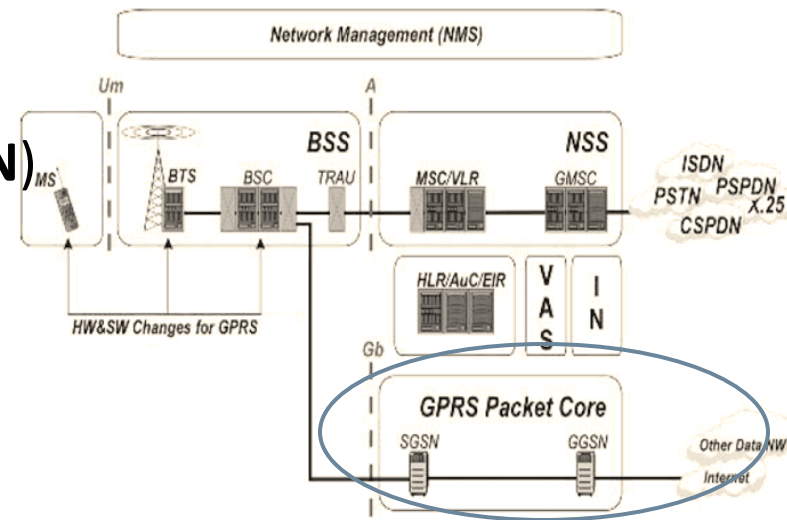

2.5G – GPRS (General Packet Radio Service) (2/2)

15

- With GPRS, the **network resources are better utilised**.
 - ▣ **No resources are reserved**. The data is sent in packages depending on the available network capacity
 - ▣ **Cost less** than circuit-switch services since **communication resources are shared** than dedicated only to one user
- With a GPRS connection, **higher speeds** than GSM (9 Kbits/s) can be achieved (typically **32 - 48 Kbits/s**)
- GPRS was used for services such as:
 - ▣ Multimedia Messaging Service (MMS),
 - ▣ Internet communication services such as email and World Wide Web access.

3G – UMTS (Universal Mobile Telecommunication System)

16

- ❑ **Launched around 2001**
- ❑ Frequency bands **around to 2 GHz**
- ❑ Based on **W-CDMA** (5MHz Carrier bandwidth used, Spread Spectrum Technique)
 - ❑ 2G and 2.5G Networks used a Carrier Bandwidth of **200KHz**
- ❑ Achieved **better spectral efficiency** than Previous Generations
 - ❑ Can **support more users** compared to 2.5G Network.
 - ❑ Can achieve **higher bit rates** than 2.5G Network.

Radio interface	Peak downlink rate
W-CDMA	Up to 384kbps
HSPA	Up to 14.4Mbps
HSPA+	Up to 42Mbps

LTE	Up to 45Mbps (5MHz)
	Up to 326Mbps (20MHz)
LTE-Advanced	Up to 1Gbps downlink (using up to 50MHz)

3G – UMTS (Universal Mobile Telecommunication System)

17

- Radio Access Equipment for 3G Networks (which is based on WCDMA) as such are **not compatible** with GSM equipment (which is based on TDMA/FDMA)
- A new part that will establish and maintain the 3G connections (i.e., the WCDMA connections) in the radio interface is required (**UTRAN**)

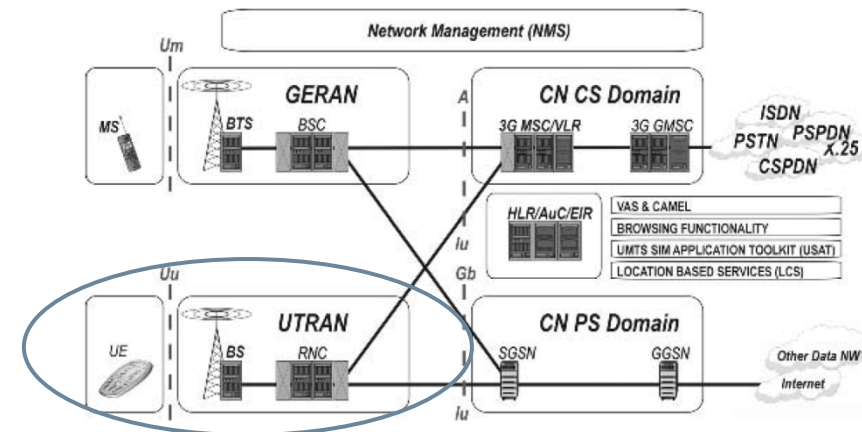

- Two new elements are included:
 - **Base Station (BS; NodeB):** Establish the W-CDMA physical channels
 - **Radio Network Controller (RNC):** The Controlling element of the UTRAN that also Implements Radio Resource Management (RRM)!!!

3G – UMTS (Universal Mobile Telecommunication System)

18

- **Packet Priority is provided** based on **required QoS parameters** of the service (Guaranteed bit rate, Delay, BER etc.). Support **four different QoS classes** of services.
 - ▣ **Conversational** (Real time – Voice, Video Call)
 - ▣ **Streaming** (real time – Video and audio streaming)
 - ▣ **Interactive** (non real time – web browsing)
 - ▣ **Background** (e-mails)
- **Services supported:** All services supported by 2G and 2.5G, plus a variety of other multimedia mobile services:
 - ▣ Video Call
 - ▣ Audio and Video streaming
 - ▣ Video on demand
 - ▣ Mobile TV

4G Networks

19

- 4G, also known as **Heterogeneous Networks** → Launched around **2012 with LTE**
- The concept of 4G can be summarized as follows:
 - “4G is a **fully IP-based** integrated system of systems and network of networks offering any kind of services on an "Anytime and Anywhere" basis, and at **higher data rates** than previous generations”

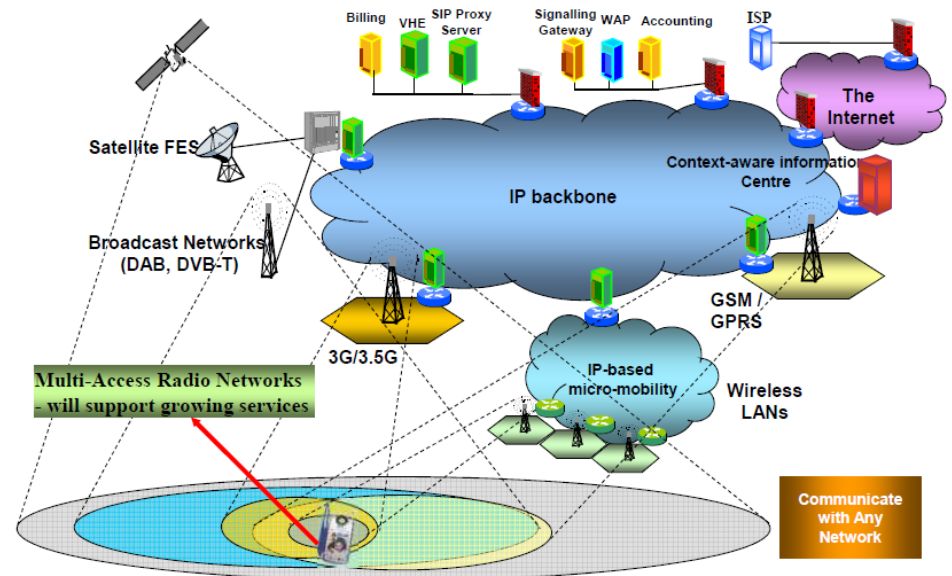
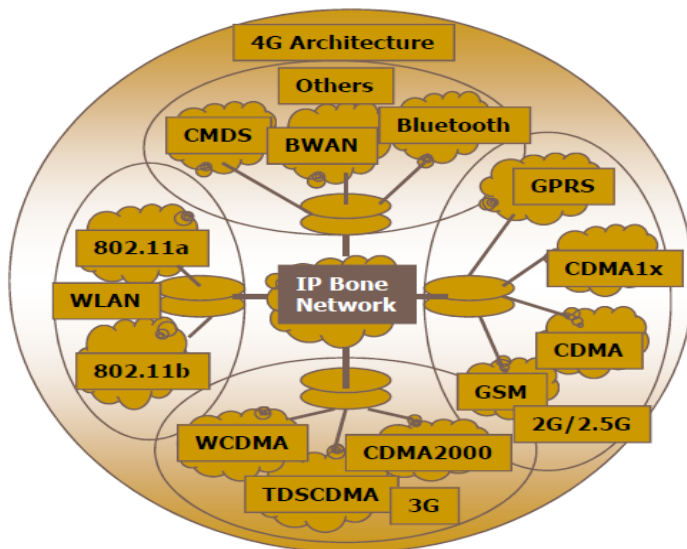

4G Compared to 3G Networks

20

- Capable of providing **higher data rates** in the level of (this was also the driving force for 4G Networks):
 - ▣ **100 Mbits/s** while the client physically moves at high speeds relative to the station, and **1 Gbits/s** while client and **station are in relatively fixed positions**
- **Spectrally efficient system** (i.e., utilize the available radio resources more efficiently)
 - ▣ Will provide **high network capacity**: Support **more simultaneous users per cell** than previous generation networks.
- Support **seamless handoff** across **Heterogeneous Networks**
 - ▣ Able to maintain the service when a user is moving between heterogeneous network technologies (e.g., 3G, 4G, WiFi, Wimax, etc.)
- **LTE** is considered as a 4G Network System (actually 3.9G as it does not fully meet the technical criteria of a 4G wireless service).

Long Term Evolution (LTE)

21

- Despite constant evolution, **3G (UMTS) was approaching a number of inherent design limitations** in a manner similar to what GSM and GPRS did a decade ago.
- Therefore, the **3GPP decided to once again redesign both the Radio Network and the Core Network.**
- The result is commonly referred to as ‘**Long-Term Evolution**’ or **LTE** for short.

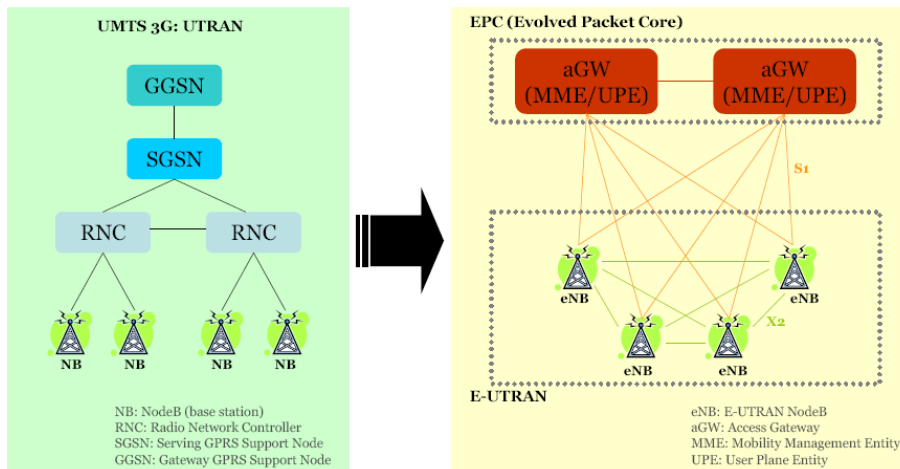

Mobility Management Entity (MME)

User Plane Entity (UPE)

Long Term Evolution (LTE)

22

- When UMTS (3G) was designed, WCDMA with a **Carrier Bandwidth of 5 MHz** was specified for the radio interface.
- However, even if higher bandwidth is used, WCDMA is **not ideal for the higher data rate channels demanded for 4G Networks** (i.e., up to 100 Mbits/s – 1 Gbits/sec).
- The main reason is that WCDMA is a **Single Carrier Transmission** scheme

Long Term Evolution (LTE)

23

- With **single Carrier Transmission** schemes, even if the carrier bandwidth is increased to achieve higher data rates, **the time between subsequent symbols need to become shorter** to take advantage of the additional bandwidth (as more bits have to be sent at the same amount of time).
- That is by **increasing the Data Rate**, the time between subsequent symbols is decreased, causing the negative effect of the **InterSymbol Interference (ISI)**

Long Term Evolution (LTE)

24



8bps



16bps



32bps



64bps

Single Carrier Scheme (Assuming 1 bit per symbol)

Inter-Symbol Interference (ISI)

25

- The **shorter** the time between **subsequent Symbols**, the **greater** the impact of **InterSymbol Interference (ISI)**, which degrades the quality of the signal considerably.

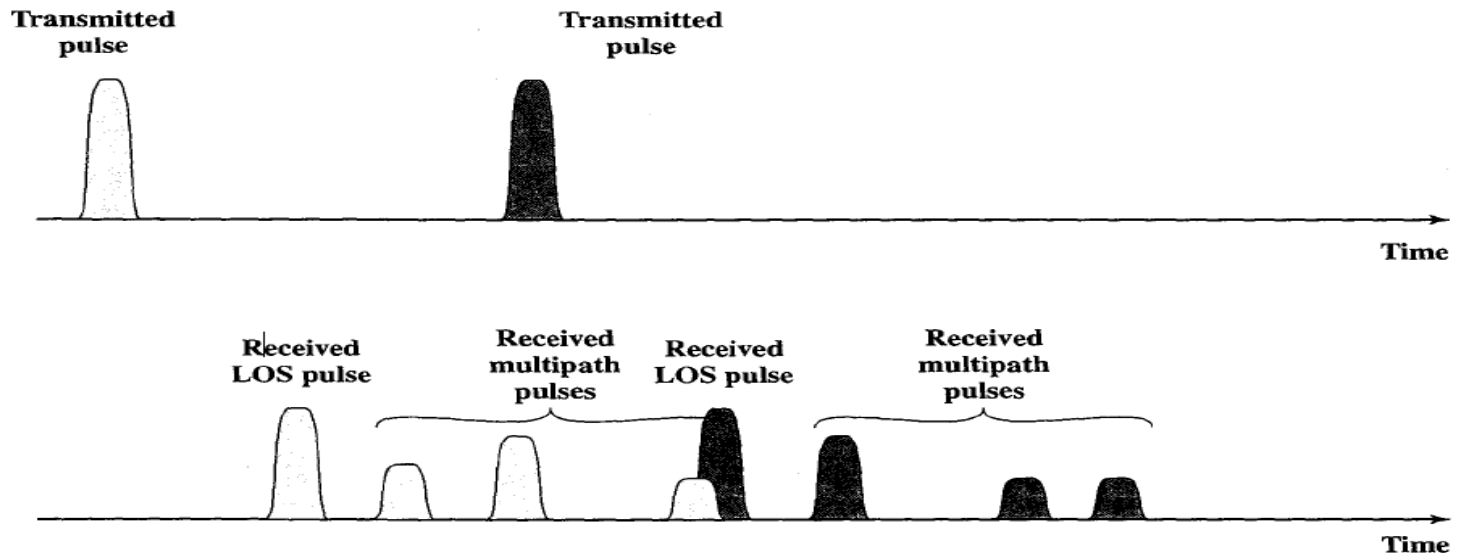

Long Term Evolution (LTE)

26

- To mitigate the problems of **InterSymbol Interference (ISI)** to some degree, **Multicarrier Transmission** is needed.
- Therefore, with LTE, the first major change was the **completely different air interface (based on OFDM; Orthogonal Frequency Division Multiplexing)** specified to **significantly increase the data rates in the air interface.**

Long Term Evolution (LTE)

27

- Instead of transmitting the data over a single carrier, LTE uses **Orthogonal Frequency Division Multiplexing (OFDM)** that transmits the data over **many narrowband carriers**.
- A high data rate **data stream** is split into **many slower data streams** that are **transmitted simultaneously**, using many different narrowband carriers (180KHz each).
- As a consequence, the **achievable data rate** compared to 3G can be much greater even in the same bandwidth, since the **ISI effect can be greatly reduced**.
- *If the time between consecutive symbols is kept greater than the Delay Spread then the **ISI** is mitigated.*

Long Term Evolution (LTE)

28

OFDM Concept: Single-Carrier Vs. OFDM

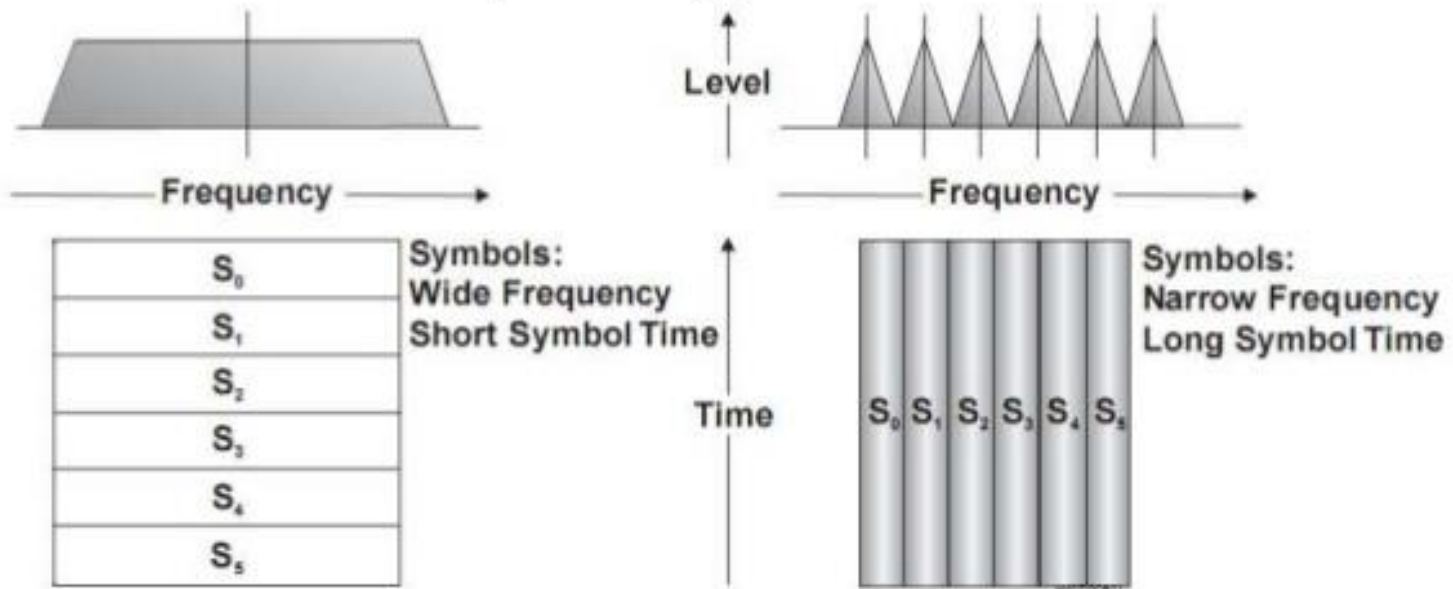

Single-Carrier Mode:

- Serial Symbol Stream Used to Modulate a Single Wideband Carrier
- Serial Datastream Converted to Symbols (Each Symbol Can Represent 1 or More Data Bits)

OFDM Mode:

- Each Symbol Used to Modulate a Separate Sub-Carrier

Long Term Evolution (LTE)

29

- The second major change of LTE compared to previous systems is the **Adoption of an All-IP approach**.
- While **2G/3G Networks** used a traditional **Circuit-Switched packet core** mainly for **voice services**, **LTE solely relies on all IP Network Architecture!**

2G/3G

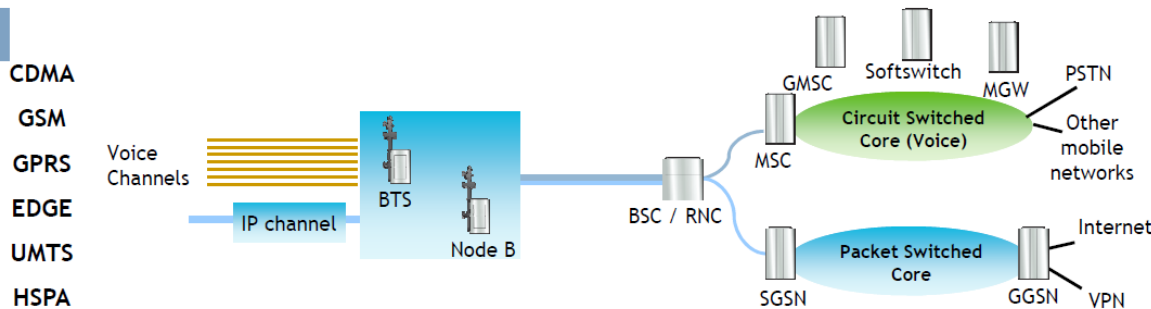

LTE+EPC

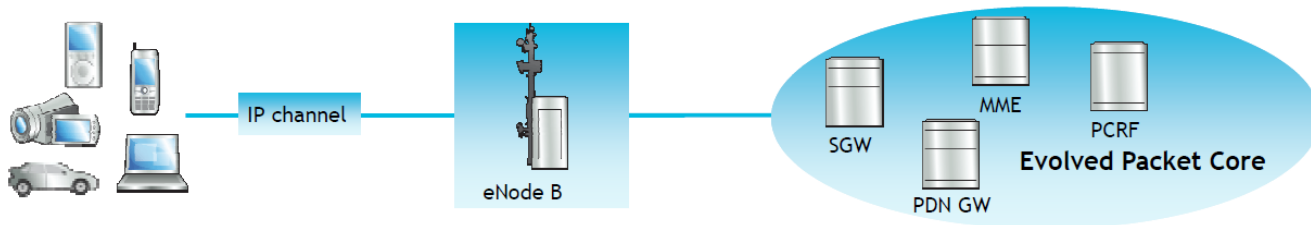

**An All IP-based
Core Network
Evolved Packet
Core (EPC)**

Long Term Evolution (LTE)

30

- An **All-IP** network architecture greatly **simplifies** the **design** and **implementation** of both the **Radio Network** and the **Core Network**.

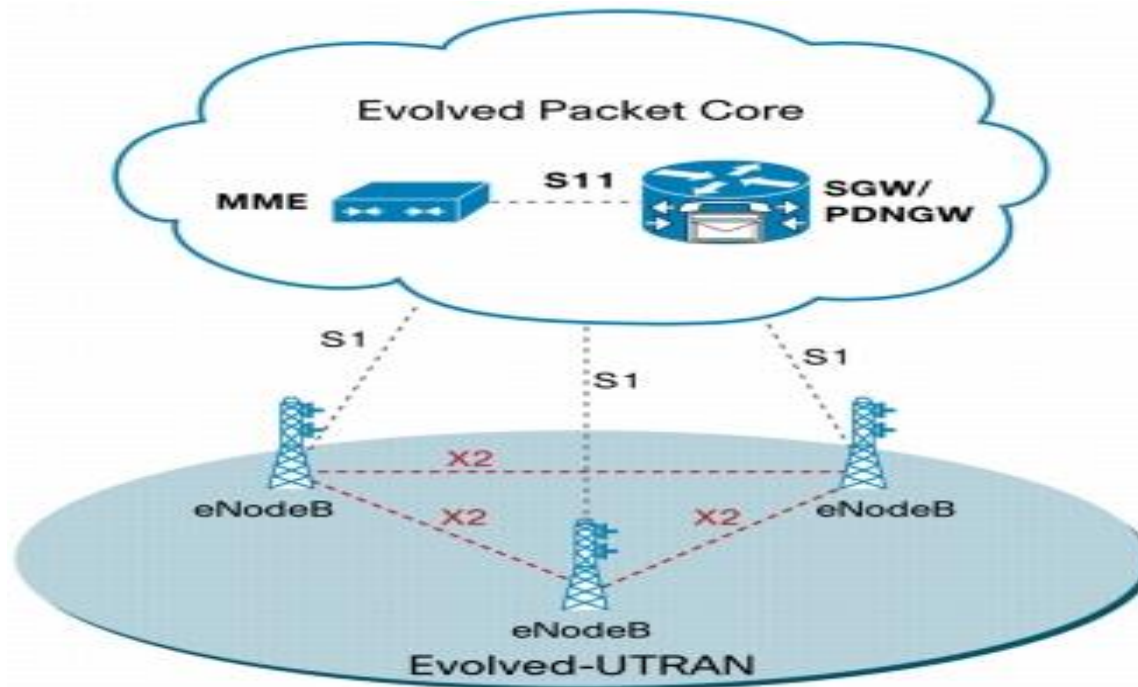

Long Term Evolution (LTE)

31

- To further **simplify the network architecture** and to **reduce user data delay**, fewer logical and physical network components have been defined in LTE → **The RNC is removed** and its functionality is spitted between the eNodeBs and the MME.
- In practice, this has **resulted in data delay times of less than 25–30 milliseconds** (used to be 150 ms for UMTS).

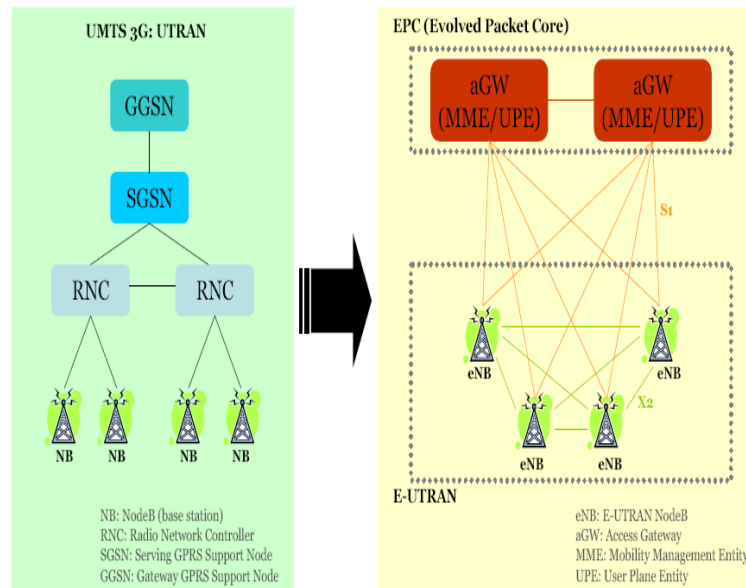

Overview of LTE Architecture

32

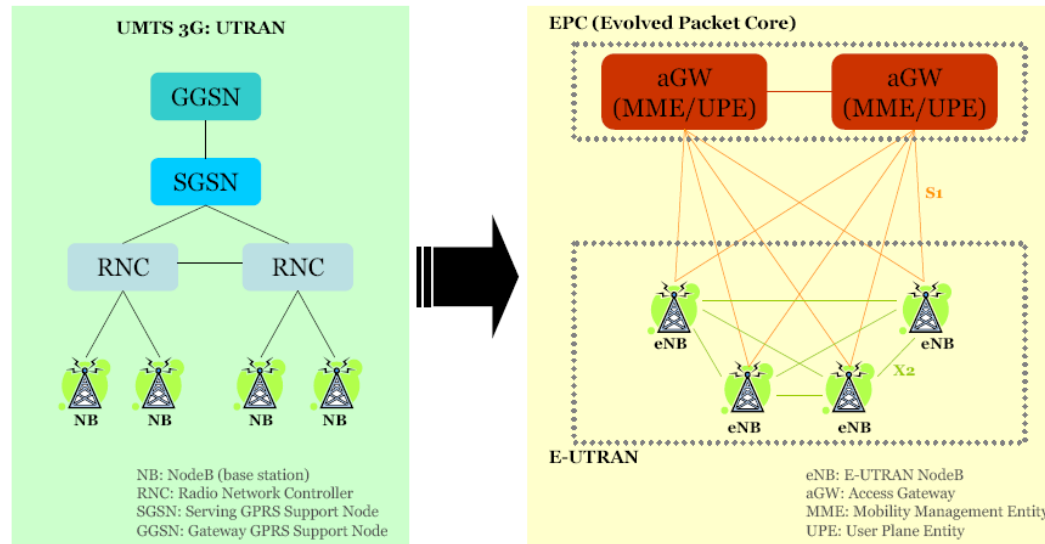

The **removing of RNC network element** and the **introduction of X2 interface for direct communication between the eNodeBs** makes the radio network architecture **more simple and flat**

→ Leads to **Lower Networking Cost, Higher Networking Flexibility** and **lower data delays.**

5G Networks

Future Mobile Networks

33



- With a total of around **4.6 billion mobile subscribers**, the forthcoming data explosion promised by the wide deployment of the **Internet of Things (IoTs)....**

By the end of the year 2020, **more than 50 billion connected devices** are expected to **utilize the cellular network services**

Also this will result in a **tremendous increase in data traffic in the Network**, as compared to now.

5G Networks

Future Mobile Networks

34

- The current generation of 4G Networks are **not sufficient to address** these demands
- To make the vision of 5G Networks possible, **radical improvements** need to be made on existing 4G Networks Infrastructure, demanding for **new architectures, methodologies** and **technologies**.

5G Networks

Future Mobile Networks

35

- A **few key features** (Demands) of 5G networks compared to the fourth generation (4G) of the cellular networks, are enlisted as below:
 - i. **10 – 100x** in the **number of connected devices**,
 - ii. **1000x** higher mobile **data volume per area**,
 - iii. **10 – 100x** higher **data rate**,
 - iv. **1 ms data user** latency,
 - v. **99.99%** network availability (to admit users),
 - vi. **100%** coverage,
 - vii. **x/10** energy consumption
 - viii. **x/5** network management operation expenses (OPEX), and
 - ix.

5G Networks

Future Mobile Networks

36

- The **challenges** that need to be addressed, in order to make the vision of 5G Network a reality, **are not trivial**.
- Many industries and organizations are **working towards the development of 5G Networks** and the **definition of the standards** that will **realize the 5G Networks**.
 - ▣ E.g., Alcatel-Lucent, DOCOMO, GSMA Intelligence, Huawei, Nokia Siemens Networks, Qualcomm, Samsung, Vodafone, the European Commission supported 5G Infrastructure Public Private Partnership (5GPPP), and Mobile and Wireless Communications Enablers for the Twenty –Twenty Information Society (METIS)

However, the **standards related to the 5G Networks vision** as well as the **expected designs and architectures for 5G networks are yet to be evolved**, as **several challenges** need to be **handled first**.

5G Networks

Future Mobile Networks

37

For more information about the current research on 5G, a very good survey appears in:

N. Panwar, S. Sharma, A. Singh, “A Survey on 5G: The Next Generation of Mobile Communication” Elsevier, Physical Communication, Special Issue on Radio Access Network Architectures and Resource Management for 5G, Vol: 18, Part: 2, pp: 64 – 84, March 2016

Book: Jonathan Rodriguez, “Fundamentals of 5G Mobile Networks, 2015 John Wiley & Sons, Ltd.

Ερωτήσεις;